

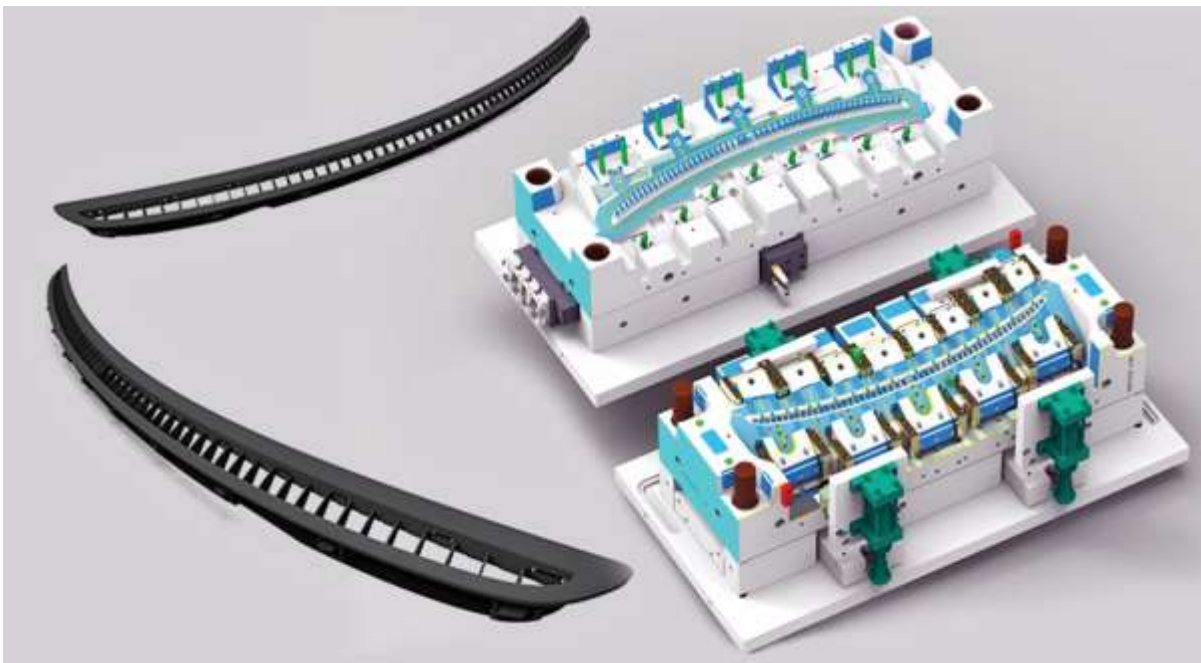

One Stop Shop for Precision
Moulds & Mouldings for
Automotive Interior
Components

AGENDA



- 1 Company Profile
- 2 Core Values – Vision - Mission
- 3 Industries We Serve & Company Profile
- 4 Our Journey
- 5 Quality Policy
- 6 Project Management
- 7 Mold Flow
- 8 Facility Tour
- 9 Our Expertise

My Organization Core Values

Customer First

Integrity and Honesty, Speed.

Passion

To Learn , Implement & Grow along with Team.

Innovation

Improvement , Development & Solutions, Can do Attitude.

Intrapreneur

Intrapreneurs are self-motivated , proactive, and action-oriented people who accept challenge & have leadership skills and think outside the box.

My Organization Vision

By the end of 2024, Our Vision is to be Partnering with Automotive OEM and Tier 1 suppliers by choice for Plastics Components, Sub assemblies & Value addition processes, delivering in shorter time, by using cost effective and efficient Tooling Solutions manufactured inhouse & sourced globally with latest manufacturing trends.

Number of Customers : 20

Revenue Moulds : INR 40 Cr - \$ 5 Million

Revenue Mouldings : INR 80 Cr - \$ 10 Million

Reach : Pan India / Global- North America & Europe.

Our Niche: Automotive Tooling , Injection Moulding , Assemblies & Value addition processes.

My Organization Mission

Our Mission is to be a Total solution provider company for plastic components & assemblies with cutting edge Technology, cost effective & Precision Tooling's with latest automation to accelerate mutual success.

Operating Principal's

Total Solution Provider

With streamlined processes in place, we transform creative ideas into products and concepts; and project plans into unique solutions – all delivered and installed on time and to specification.

Latest Technologies

To make use of latest manufacturing technologies in our process like High end CAD/CAM, Mold Flow software, Robotics, ERP, IOT, Industry 4.0 and Inventory enabled operations.

Cost Effective & Precision Tooling's

By offering cutting edge technologies like Mold Flow validated Mould Design, 5 axis and high-speed machining, additive manufacturing, innovative standard solutions, hardened moulds – PVD coating moulds are cost effective during Injection Molding process

Company Profile

CAM TOOLS INDUSTRIES PVT. LTD.
One Stop Shop For Precision Moulds & Moulding



Multiple Locations

Tool Room at Mumbai and Pune,
Moulding Shop at Pune.



Integrated capabilities

Mould Design, Mould Making, Mould-trials,
Mouldings and Part-assembly.



Full-Service Supplier

Precision Moulds & Mouldings for
Automotive OEM and Tier 1 suppliers.



Professional Support

Design and Manufacturing of Precision Moulds
at “Best cost” and in “Short lead-time”.



IATF Certification



**ISO 9001:2015
Certified facility**



**ECO Vadis
Certification
In process**



**VDA Certification
In Process**

Production Capabilities



Mumbai Tool Room

- Manufacturing Capacity 60-80 Moulds Per Year
- Mould Mfg. Capacity range from 50 T to 650 T
- 7500 Sq. Feet Facility
- Crane up to 7.5 Tones
- Total 5 Cranes



Pune Tool Room

- Manufacturing Capacity 40-50 Moulds Per Year
- Mould Mfg. Capacity range from 50 T to 1300 T
- 8000 Sq. Feet Facility
- Crane up to 10 Tones
- Total 2 Cranes



Pune Injection Moulding Unit

- 15 Moulding Machines from 50 T to 660 T
- Hot Stamping / Pad Printing capabilities / Ultra Sonic Welding
- 54000 sq feet – Chakan MIDC Plot
- Presently running 240 + Moulds.
- Dedicated Team - 24 X 7 Operation.
- Crane up to 30 Tones

Why Us ?



Professionally Managed
Family owned business



**Passionate Mould Maker & Advancing
towards Injection Mouldings**



All Facilities
Under one roof



Dedicated Project Management
For on time delivery with strong Techno commercial
Communication Skills.



At Par Quality
With imported Moulds



Quick Response Time

Industries We Serve

87%

of moulds we made
in last 3 years were
from **Automotive**
Segment

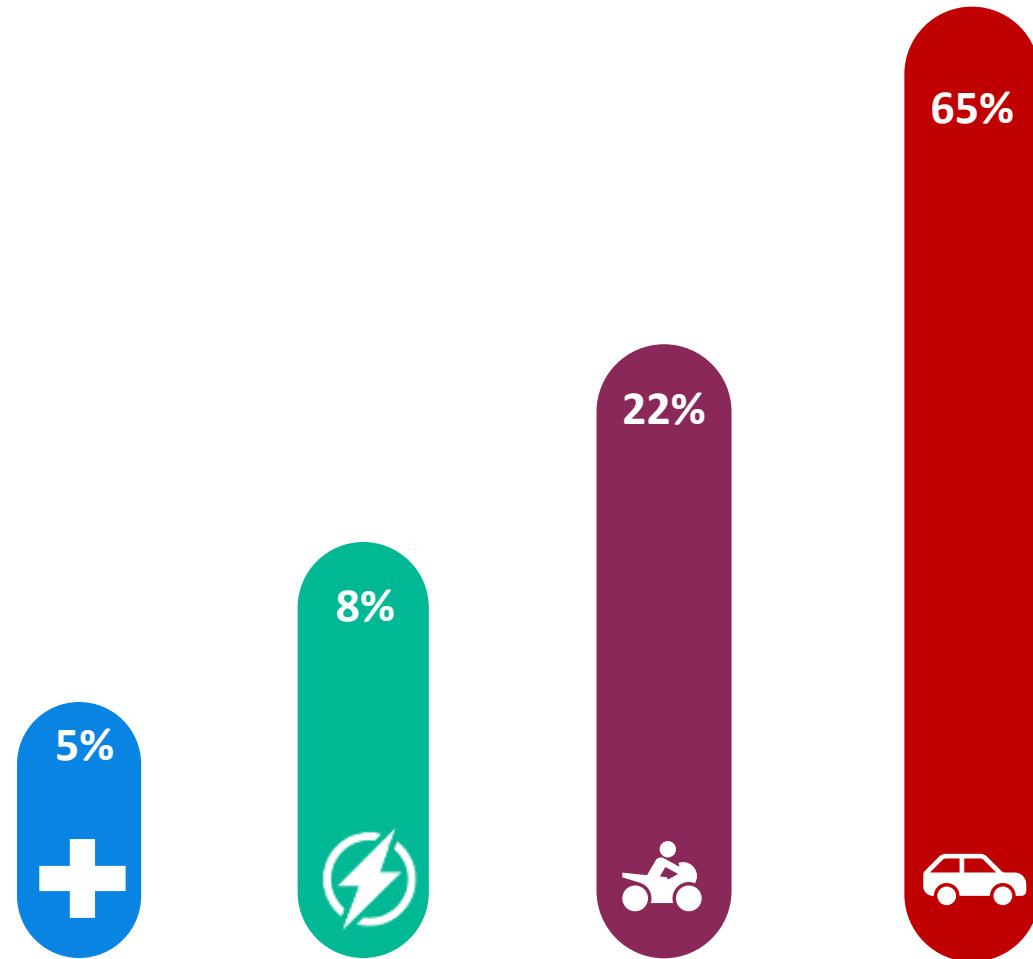

Our Journey

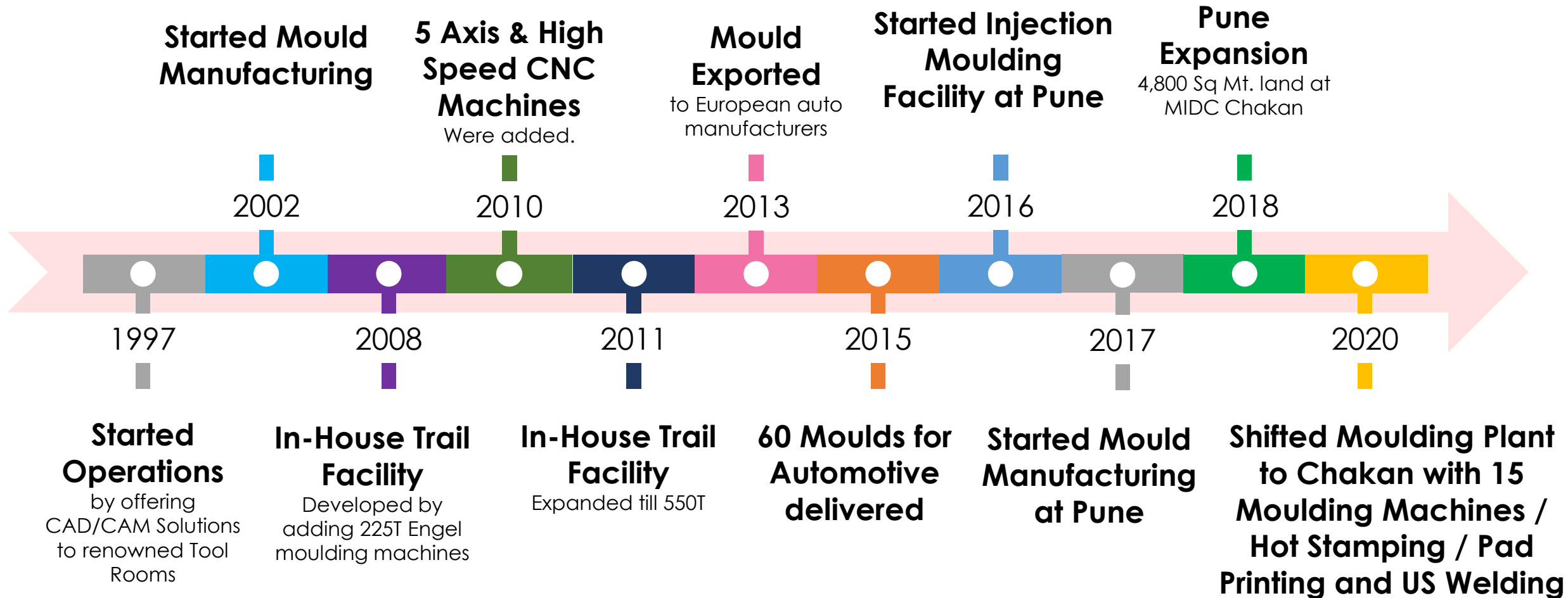

Expansion Plan 2022 – 2024

For Injection Moulding Shop & Tool Room at Pune

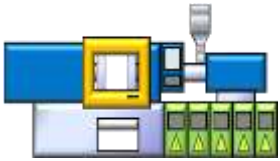

Injection Moulding Plant

- Moulding Machines up to 1300 T capacity.
- 2K Injection Moulding.
- Special Process



Mould Manufacturing

- Increase Capacity from 850 T to 1300 T.
- Double Column CNC Machine
2.5 Meter X 1.6 Meter with Positional 5 axis.
- Die Spotting Press of 400T with Table size
2.5 Meter X 1.6 Meter



Recruitments

- For Tool Room Team.
- For Injection Moulding Plant



Industrial Land -

Adding additional Land Bank of 45,000 Sq Feet – Total Land 2.5 Acres



CAM TOOLS MUMBAI TOOL ROOM FACILITY LIST

LIST OF MANUFACTURING SETUP

CNC MACHINING CELL

Description	Make	Travel Size	Qty	Location
CNC MACHINING CENTRE - TOTAL 5 NOS	DECKEL DMU 60 T- 5 Axis	630 x 500 x 500	1	<i>CAM TOOLS -Mumbai</i>
	DECKEL DMC 1035V	1050 X 550 X 500	1	<i>CAM TOOLS -Mumbai</i>
	COSMOS CVM 1060	1050 X 610 X 600	1	<i>CAM TOOLS -Mumbai</i>
	COSMOS CVM 640	650 X 450 X 500	1	<i>CAM TOOLS -Mumbai</i>
Graphite Machining Centre	BFW BMV 45	600 x 500 x 400	1	<i>CAM TOOLS -Mumbai</i>
CNC MACHINING CENTRE	YCM DCV3016B	3060 X 1600 X 762	1	VENDOR

EDM MACHINING CELL

Description	Make	Tank Size	Qty	Location
CNC EDM	JOEMARS JMNC 62	1500 x 1100 x 500	1	<i>CAM TOOLS -Mumbai</i>
CNC EDM	HCM 5040	1200 X 700 X 400	1	<i>CAM TOOLS -Mumbai</i>
CNC EDM	HCM 4030	1050 X 600 X 400	1	<i>CAM TOOLS -Mumbai</i>
ZNC EDM	JOEMARS JM 430	1050 X 600 X 400	3	<i>CAM TOOLS -Mumbai</i>
CNC EDM	CHMER	1600 X 1000 X 500	1	VENDOR
FANUC ALPHA ROBOFILL	FANUC	550 X 450 X 300	1	VENDOR

CAM TOOLS MUMBAI TOOL ROOM FACILITY LIST

LIST OF MANUFACTURING SETUP

INSPECTION CELL

Description	Make	Travel Size	Qty	Location
CMM PORTABLE	ROMER - HEXAGON	1000 X 1000 X 600	1	<i>CAM TOOLS -Mumbai</i>
SHADOW GRAPH	NIKKON	DIA 250 WITH 20X & 50X	1	<i>CAM TOOLS -Mumbai</i>
White Light Scanner	Steinbichler's COMOT 5	Resolution 1360 X 1024	1	<i>VENDOR</i>

MATERIAL HANDELING

Description	Make	Travel Size	Qty	Location
GANTRY CRANE	INDEF	7.5 TONNS	2	<i>CAM TOOLS -Mumbai</i>
GANTRY CRANE	INDEF	5 TONNS	1	<i>CAM TOOLS -Mumbai</i>
GANTRY CRANE	INDEF	2 TONNS	2	<i>CAM TOOLS -Mumbai</i>

CAM TOOLS MUMBAI TOOL ROOM FACILITY LIST

CAD / CAM SOFTWARE DETAILS	USER DETAILS
Unigraphics NX-9 - CAD Design Software - 4 License.	4- Mould Designer With 4 Years of Experience in Mould Design for Automotive Moulds.
Autodesk - PowerShape - CAD Design & Modelling Software with ToolMaker & Electrode Module - 7 License	5- Mould Designer With 4-5 Years of Experience in Complex Mould for Automotive / Electrical / Medical Industries.
Autodesk - PowerMill - With 5 Axis Machining Module - 7 License	4- CNC Programmers with hands on experience of CNC Machining / 2- Programmers for 5-Axis trained at UK.
Autodesk - PowerInspect- Inspection Software - 2 License	2- Inspection Engineers / White Light Scanning Expertise - Steinbichler`s COMET 5

Facility Tour

Mumbai Tool Room



Facility Tour

Mumbai Tool Room



Facility Tour

Pune Tool Room



Facility Tour

Pune Tool Room



Facility Tour

Pune Tool Room – Die Spotting Press

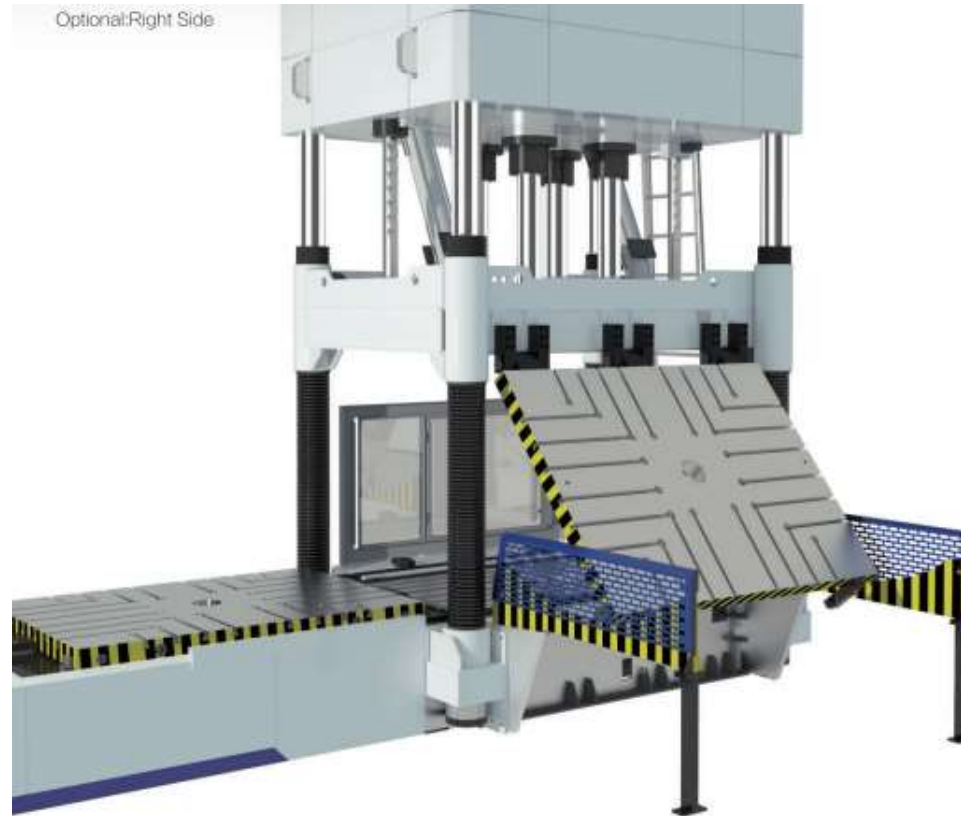

Die Spotting Machine HMG-120JM1411- 3 two way layout (right side turnover)
Table Size 1400 X 1100

Facility Tour

Pune Moulding Shop



Facility Tour

Pune Moulding Machines



Facility Tour

Pune Moulding Machines



Facility Tour

Hot Stamping



Our Expertise For Automotive Interior Moulds

CAM TOOLS INDUSTRIES PVT. LTD.
One Stop Shop For Precision Moulds & Moulding



Pillar Trims

Floor Console



Door Panel



Instrument Panel

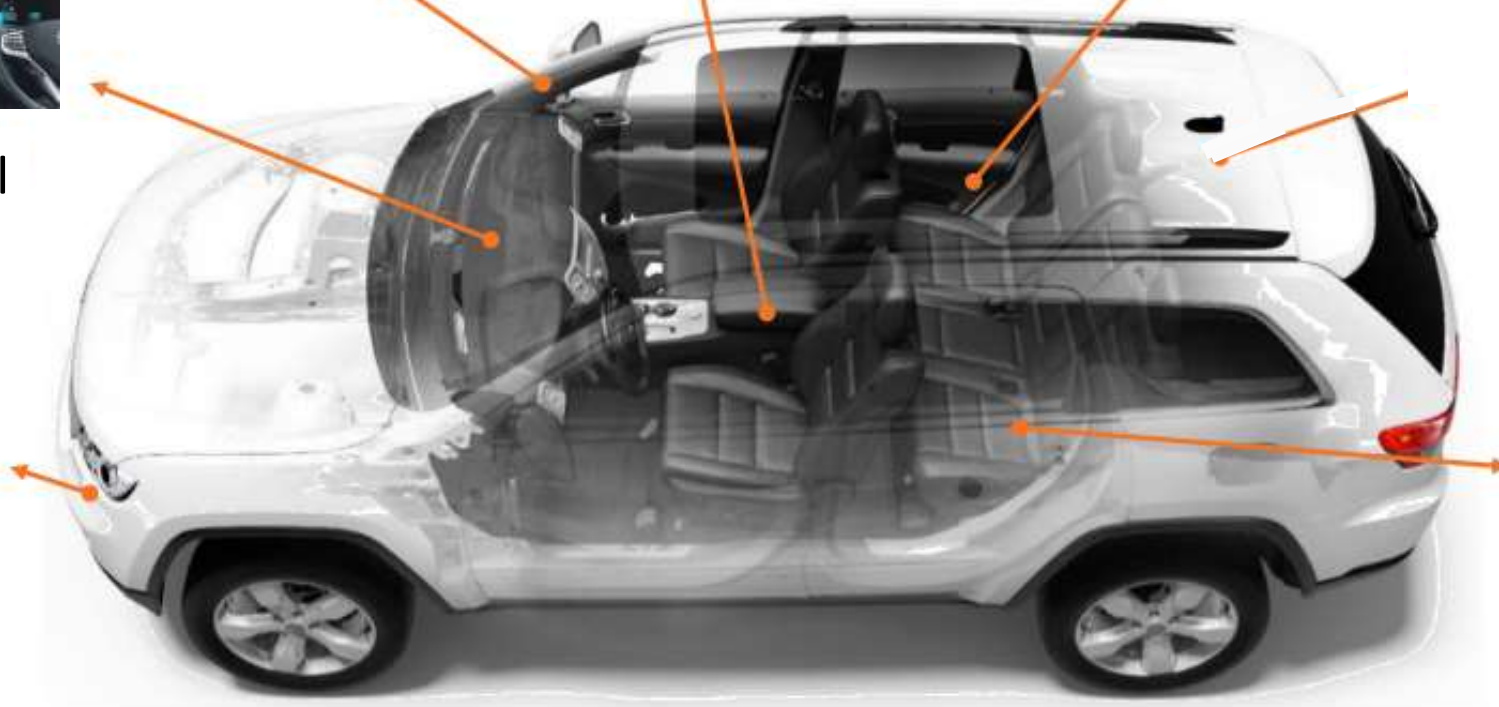

Headlights
2 Wheelers



Seating Parts

IP & CC Moulds for ISUZU



ISUZU RT64 & RT97



Console & IP Parts



12 Week Delivery



Moulds



CONSOLE CENTER

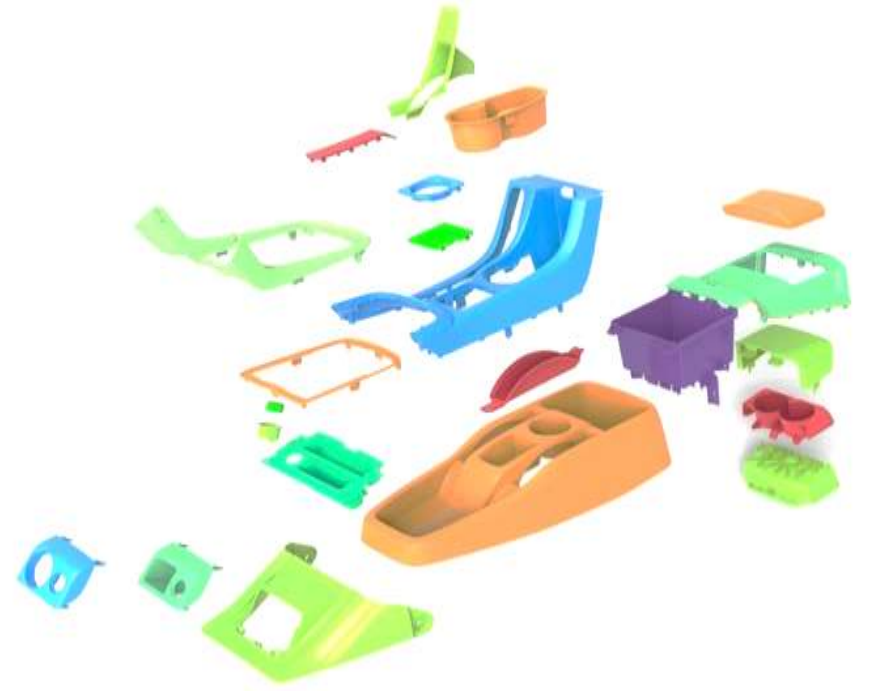

PULL BOX REAR POWER



BEZEL FRT 4 SWITCH HOLE

IP & CC Moulds for ISUZU

CAM TOOLS INDUSTRIES PVT. LTD.
One Stop Shop For Precision Moulds & Moulding



POWER DOOR FRONT



BEZEL FLR CNFL



GARNISH REAR POWER



GARNISH FRONT



PANEL FRT SD



POWER PULL BOX FRONT

IP & CC Moulds for ISUZU

CAM TOOLS INDUSTRIES PVT. LTD.
One Stop Shop For Precision Moulds & Moulding



PULL BOX FRONT



TRAY;F/FLR CNSL



PULL BOX PANEL RR



PULL BOX POWER



PULL BOX



COVER;F/FLR CNSL

IP & CC Moulds for ISUZU

CAM TOOLS INDUSTRIES PVT. LTD.
One Stop Shop For Precision Moulds & Moulding



BEZEL LOWER PANEL



COVER;F/FLR CNSL



BEZEL;F/FLR CNSL ACSRY



RUBBER FLR CNSL



TRAY;F/FLR CONSOLE



BOOT MT TYPE

IP & CC Moulds for ISUZU

CAM TOOLS INDUSTRIES PVT. LTD.
One Stop Shop For Precision Moulds & Moulding



PULL BOX FRONT



PANEL I/P LWR EXTN TR

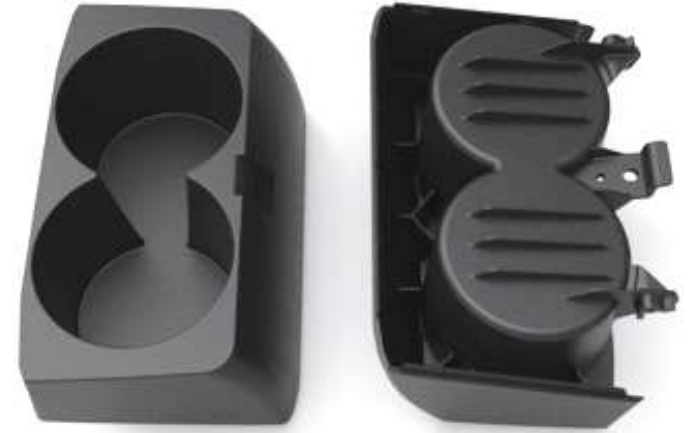

CUP HOLDER



BEZEL FRONT



F/FLR CNSL CUP



BOX CNSL BASE

IP & CC Moulds & Moulding For NEW JEEP COMPASS

CAM TOOLS INDUSTRIES PVT. LTD.
One Stop Shop For Precision Moulds & Moulding



FIAT M6 MCA



Console & IP Parts



16 Week Delivery



Moulds Project



Parts Moulding -
Welding & Pad Printing

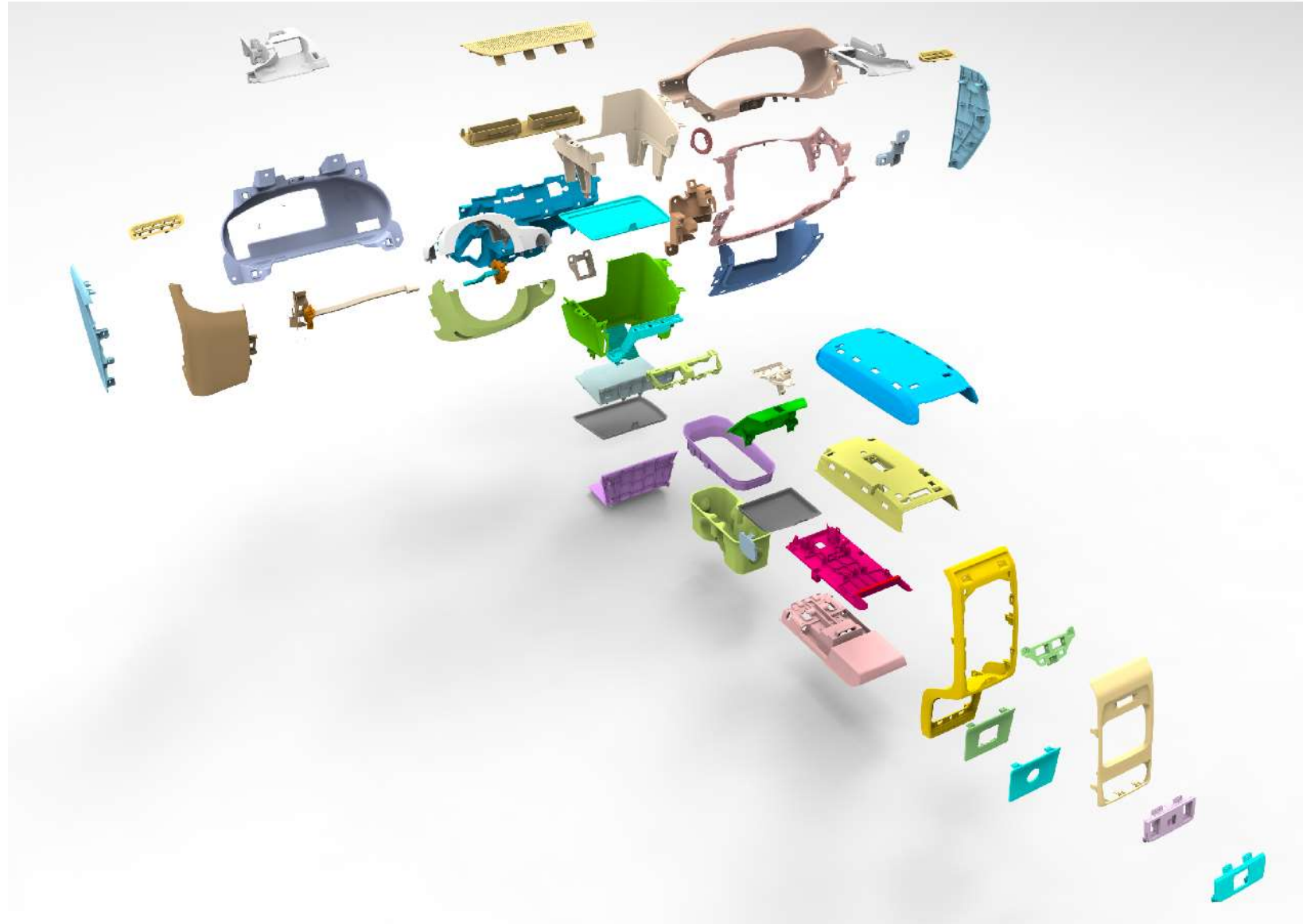

Decorative Moulds & Moulding For VW Taigun

CAM TOOLS INDUSTRIES PVT. LTD.
One Stop Shop For Precision Moulds & Moulding



VW 216 RHD & LHD



Deco & IP Parts



16 Week Delivery

22

Moulds Project

7

Parts Moulding



IP & CC Moulds & Moulding For JEEP COMPASS

CAM TOOLS INDUSTRIES PVT. LTD.
One Stop Shop For Precision Moulds & Moulding



ARMREST SUBSTRATE

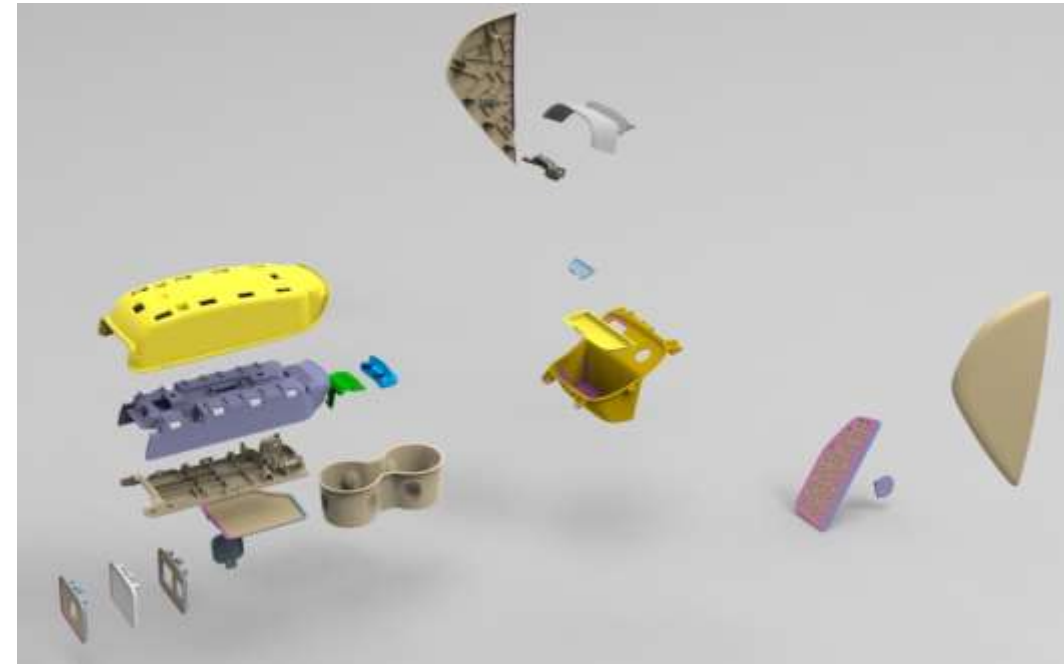

FIAT 556 MCA



Console & IP Parts



Moulds & Moulding



12 Week Delivery



LID INNER



CLOSEOUT PLATE

Air vent Moulds For HYUNDAI - VENUE

CAM TOOLS INDUSTRIES PVT. LTD.
One Stop Shop For Precision Moulds & Moulding



QXi- Hyundai



Air Vent Parts



Moulds & Moulding



12 Week Delivery



AIR VENT ASSEMBLY

**Our Expertise in
Lighting Fixtures**

**TVS Two
Wheelers**

4

Moulds



Headlights



10 Week Delivery



Hot Stamping Parts for SKODA Kushaq & Slavia

CAM TOOLS INDUSTRIES PVT. LTD.
One Stop Shop For Precision Moulds & Moulding



Lighting Moulds for SONALIKA TRACTOR

CAM TOOLS INDUSTRIES PVT. LTD.
One Stop Shop For Precision Moulds & Moulding



Sonalika Tractor



Moulds



Headlights



10 Week Delivery

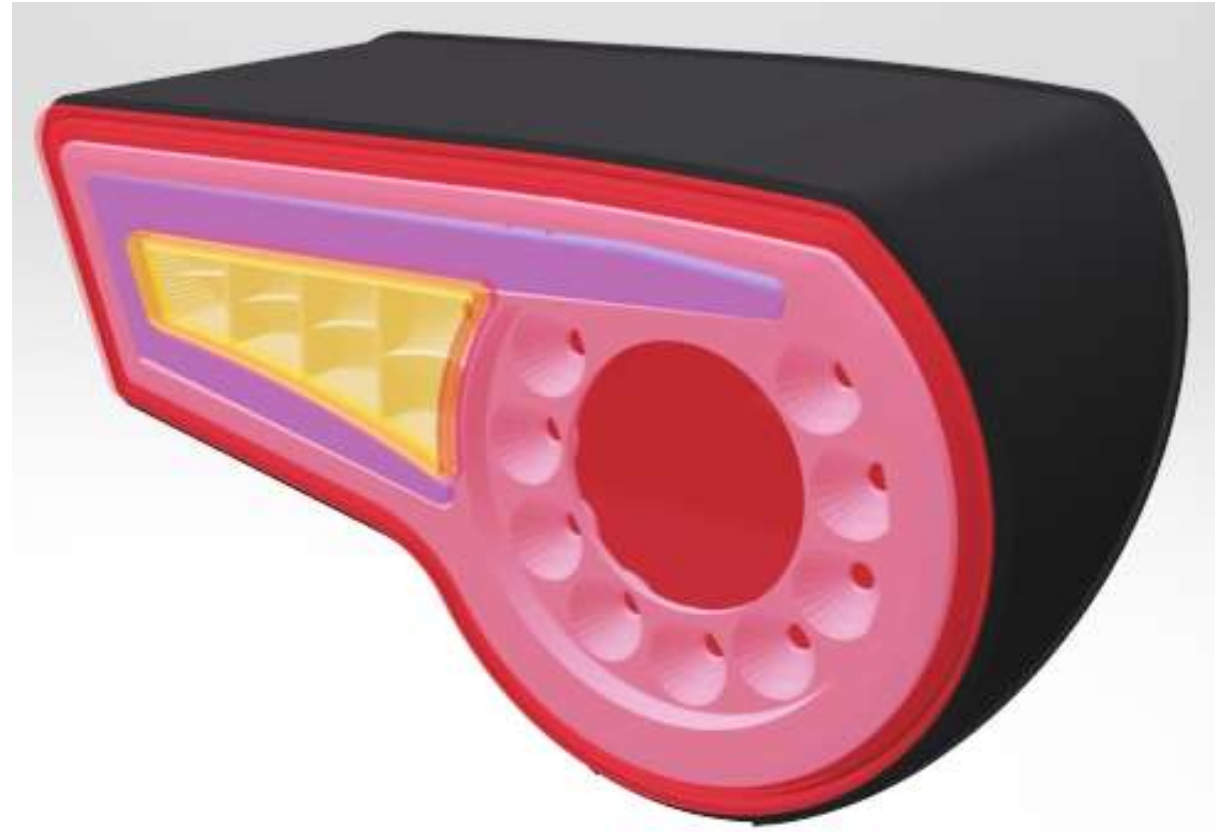

CC Moulds for RENAULTS Moulds Exported to EUROPE



J95



Moulds Exported to France



Box Floor Console Assembly



10 Week Delivery

Our INTERNATIONAL PROJECT

CAM TOOLS INDUSTRIES PVT. LTD.
One Stop Shop For Precision Moulds & Moulding

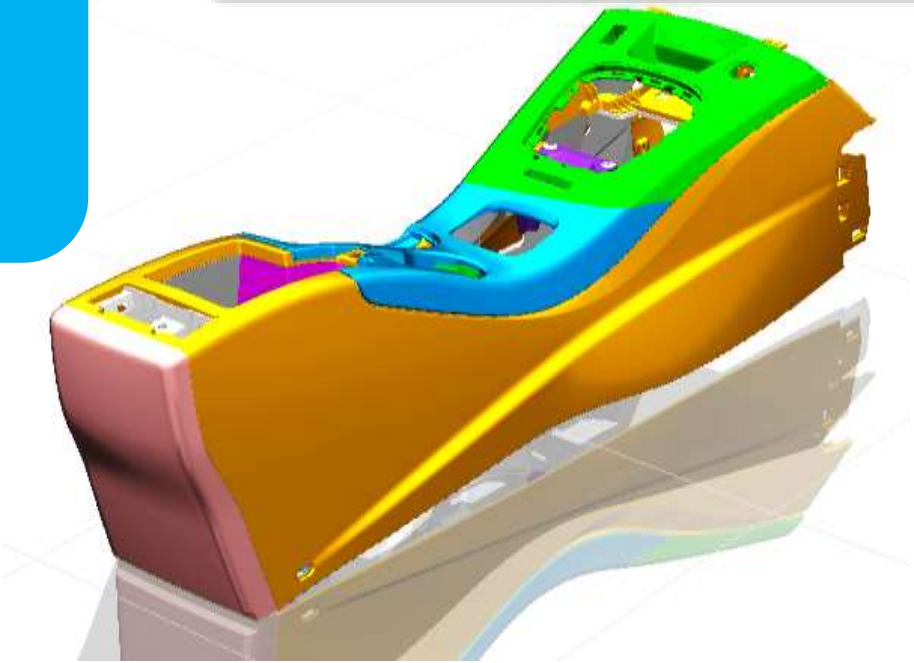

Console Fascia Upper

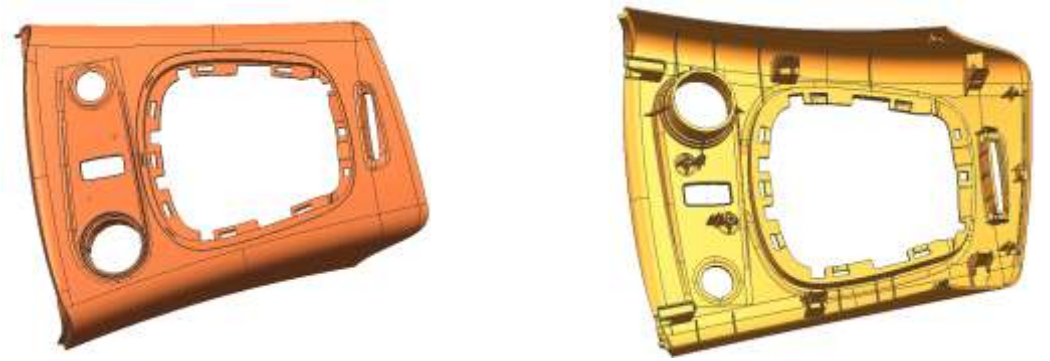

Upper Fascia

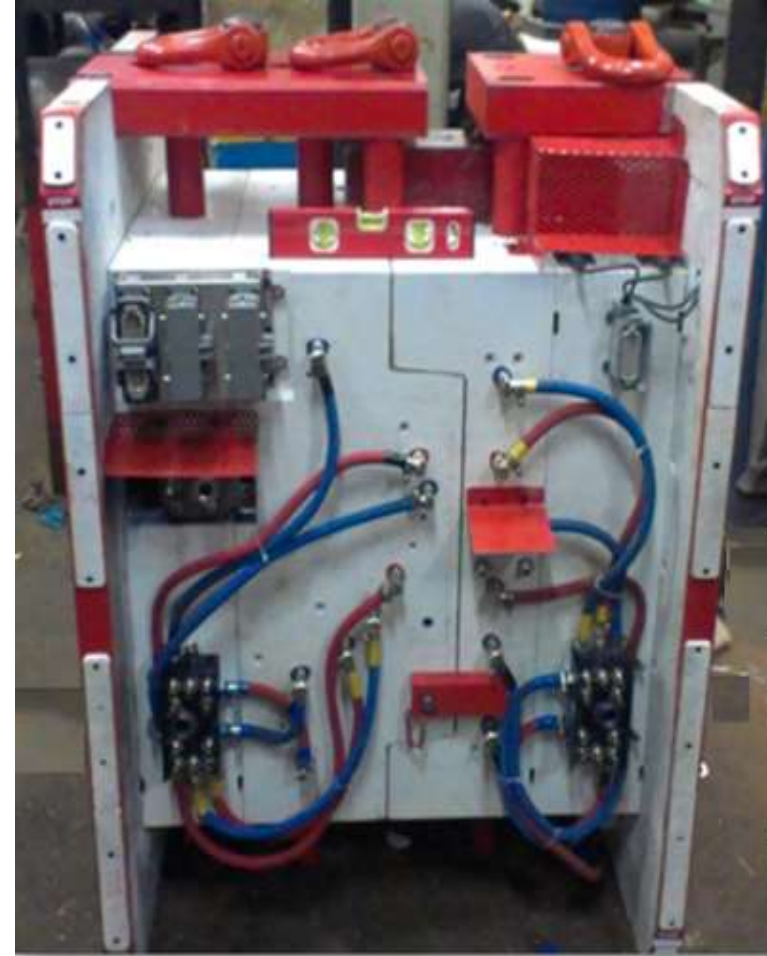

Console Fascia Upper Exported to France

IP & CC Moulds for FORD ECOSPORT



CAM TOOLS INDUSTRIES PVT. LTD.
One Stop Shop For Precision Moulds & Moulding



EcoSport B515



Console & IP Parts



Moulds



12 Week Delivery



LOWER COVER SLIDING



DEFROSTER GRILL

Storage Bins Moulds for MARUTI SUZUKI CIAZ

CAM TOOLS INDUSTRIES PVT. LTD.
One Stop Shop For Precision Moulds & Moulding



IAC G-130



Moulds



Storage Bin



12 Week Delivery

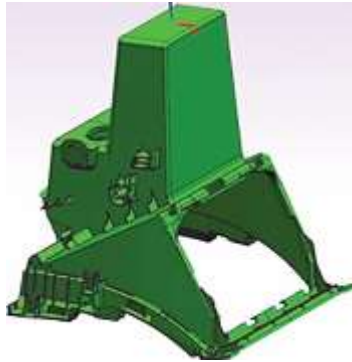
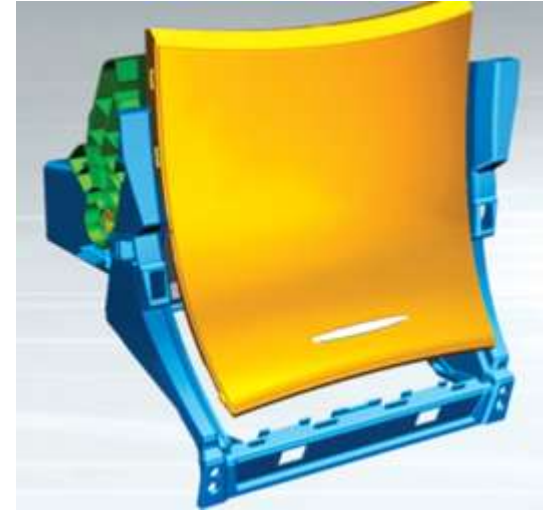

STORAGE BIN



LID OUTER

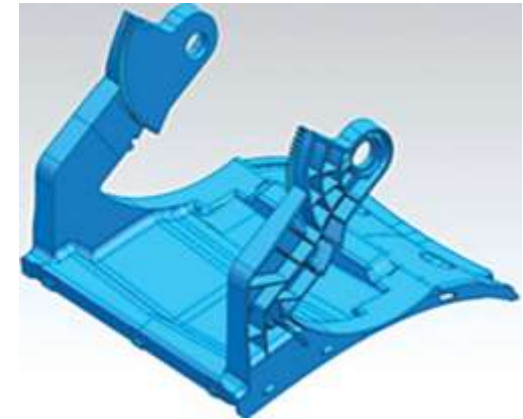

LID INNER

Pull Cup Moulds for TATA NEXON

CAM TOOLS INDUSTRIES PVT. LTD.
One Stop Shop For Precision Moulds & Moulding



Tata X-104



Door Parts



Moulds



12 Week Delivery

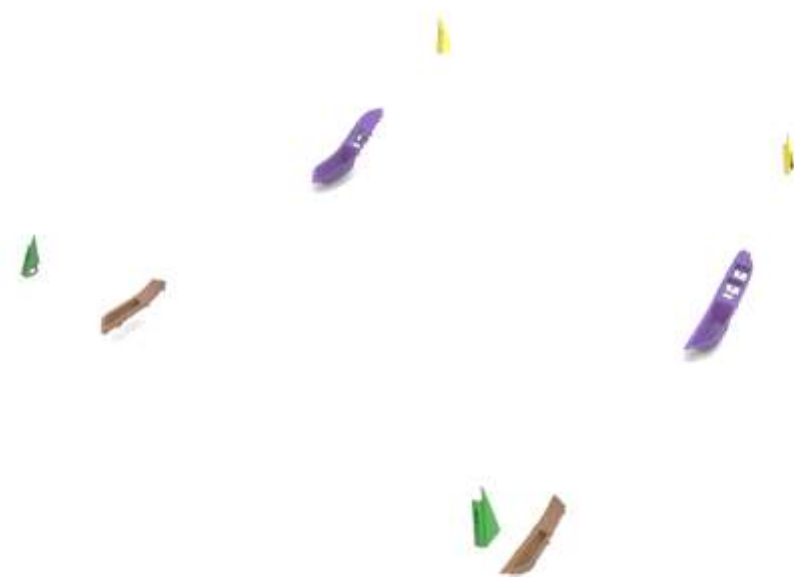

BEZEL RR DR TRIM



TWEETER SUPPORTING BRACKETS



FRONT DOOR TRIM LH RH XE



Door Panel Moulds for TATA NANO

CAM TOOLS INDUSTRIES PVT. LTD.
One Stop Shop For Precision Moulds & Moulding



Door & IP Parts



12 Week Delivery



Tata X-302



Moulds



REAR DOOR CORNER TRIM

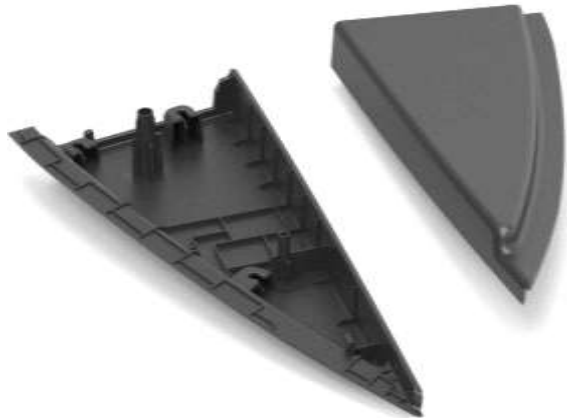

DIN AUXILARY BIN



INSERT FRONT DOOR TRIM



INSERT MOULDS/ 2K MOULDS

CAM TOOLS INDUSTRIES PVT. LTD.
One Stop Shop For Precision Moulds & Moulding

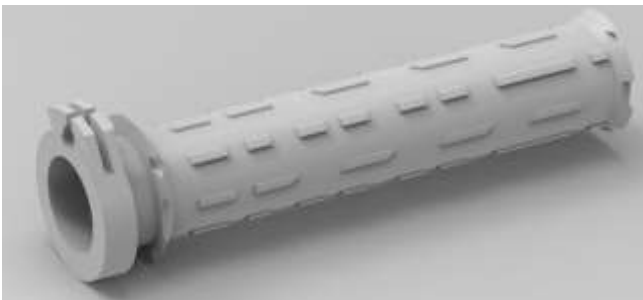
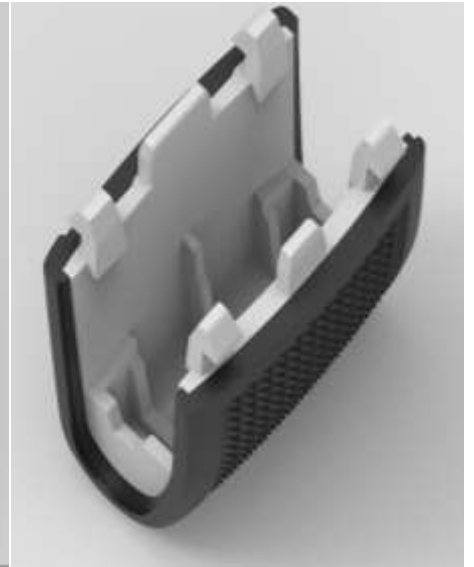
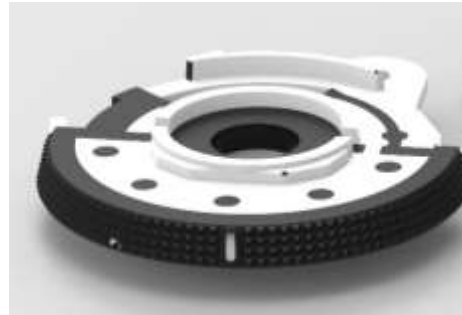
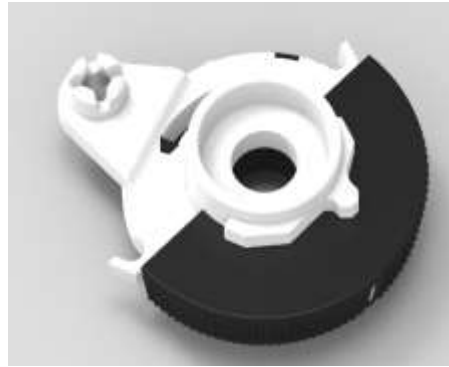

Our Patrons



***Thank
You***



- **Head Office:** M-3, Mehra Industrial Estate, Unit no-2, Opp Orkay Mill, Andheri-Kurla Road, Sakinaka, Andheri - (East), MUMBAI-400072
- **Tool Room:** Gat No 102, Behind Jhunka Bhakar Hotel, Jyotiba Nagar, Talawade, Pimri-Chinchwad Municipal Corporation, Pune 411062
- **Injection Moulding Unit:** Cam Tools Industries Pvt Ltd, E 13, Chakan Phase II, Opp New Holland, Village Shinde, Taluka Khed, Pune 410501



+91 22 2852 1358

+91 22 2851 1647



+91 9821081981



www.ctipl.in



paresh@ctipl.in